

Calculer  $x$  pour chaque figure de 1 à 10

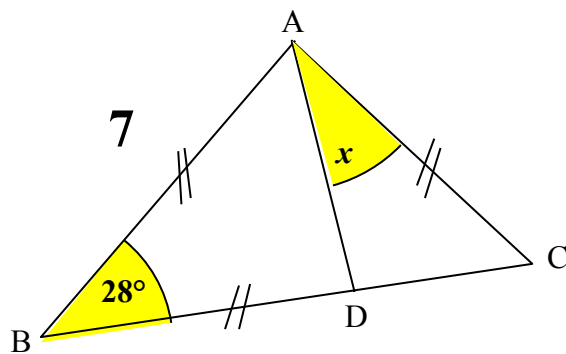

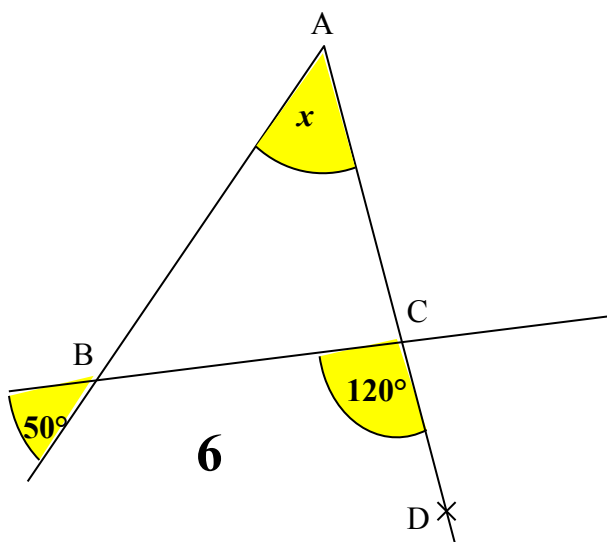

Calculer le plus de mesures d'angle dans chacune des figures suivantes

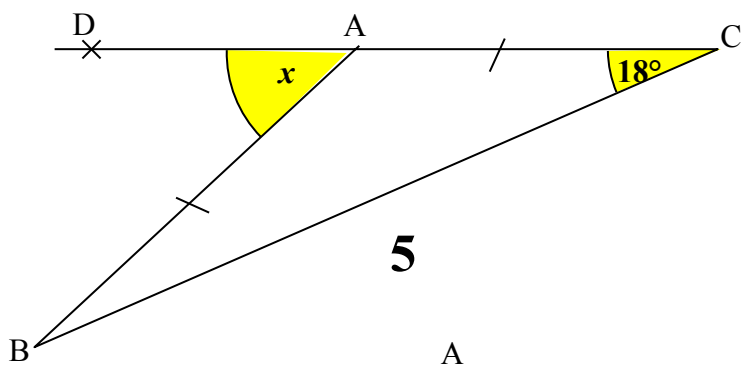
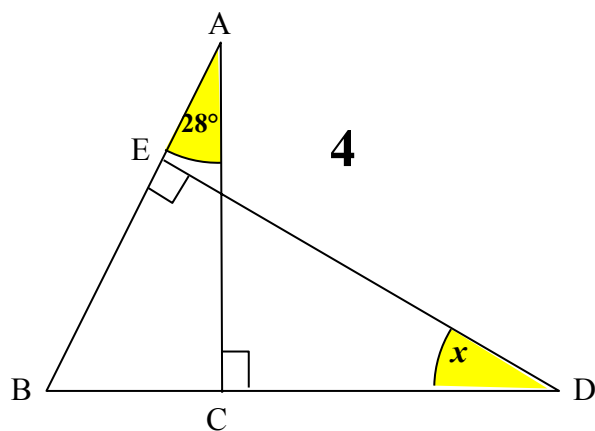
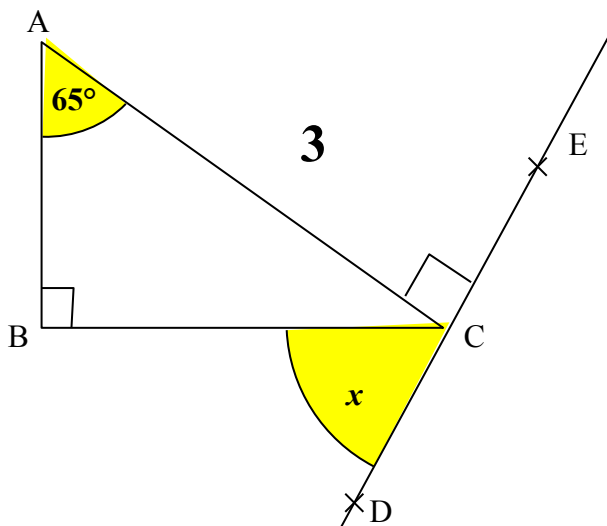
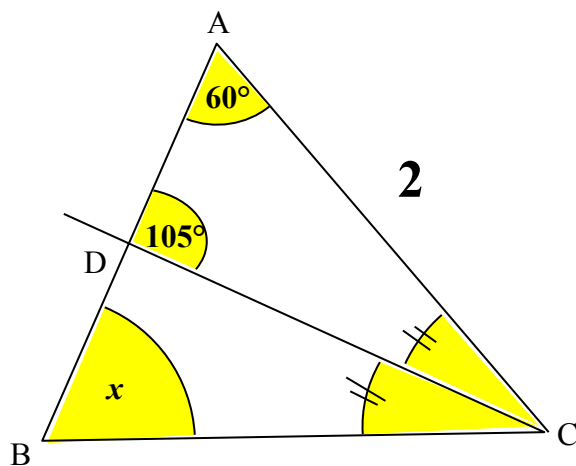
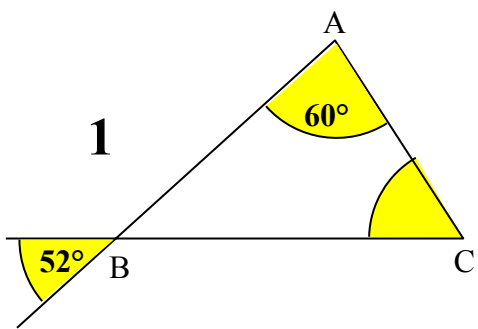
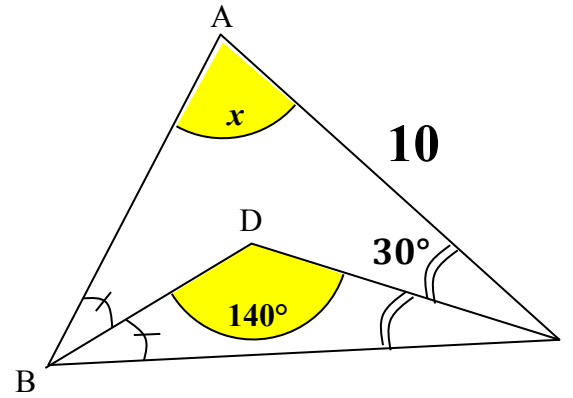
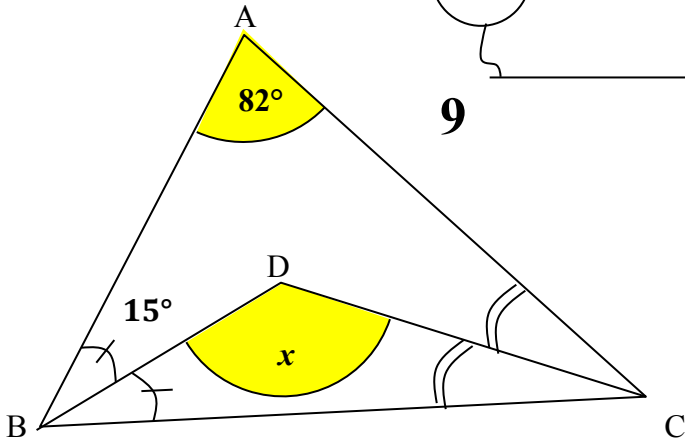
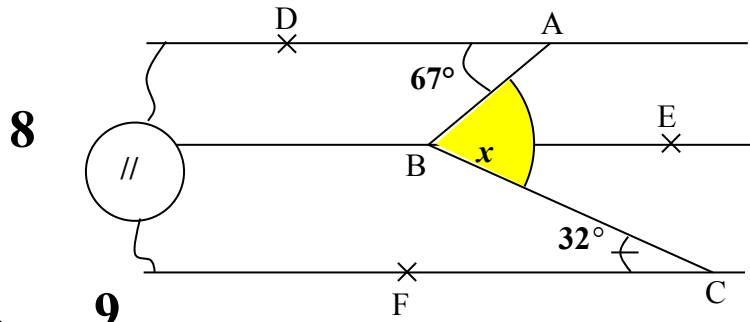